

SL-T1615IRGRC020-L55

DATA SHEET

SPEC. NO. : SZ21050601
DATE : 2022/12/3
REV. : A/1

Approved By:

Checked By:

Prepared By:

Features

- ◆ Pb free product—RoHS compliant
- ◆ Low power consumption, High efficiency
- ◆ Reliable and rugged
- ◆ Long life – solid state reliability
- ◆ Viewing angle: 120°

Package Dimension

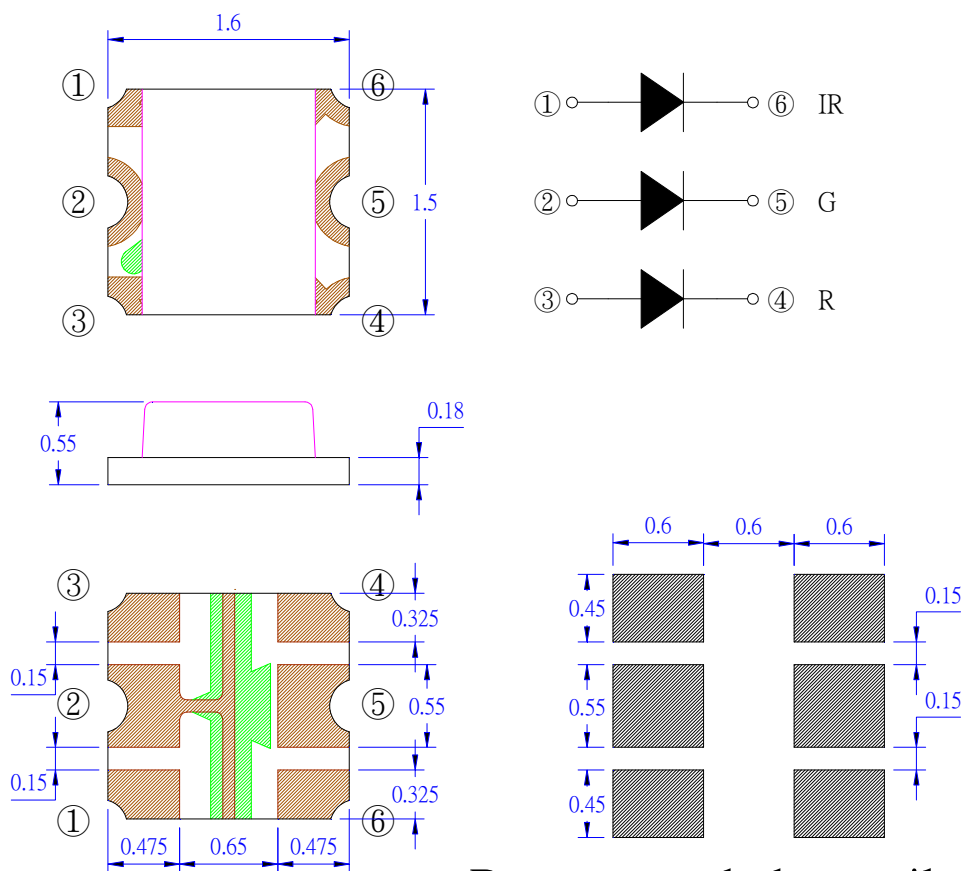

Recommended stencil size

Part NO.	Lens Color	Source Color
SL-T1615IRGRC020-L55	Water Clear	Infrared/Green/Red

Notes:

1. All dimensions are in millimeters.
2. Tolerance is ± 0.10 mm unless otherwise noted.
3. Specifications are subject to change without notice.

Absolute Maximum Ratings at Ta=25°C

Parameter	Rating			Unit
	Infrared	Green	Red	
Power Dissipation	80	108	78	mW
Peak Forward Current ^{*2}	150	100	100	mA
Continuous Forward Current	50	30	30	mA
Reverse Voltage	5	5	5	V
Electrostatic Discharge (HBM) ^{*3}	4000	2000	4000	V
Moisture Sensitivity Level ^{*1}	4			
Operating Temperature Range	-40°C to + 85°C			
Storage Temperature Range	-40°C to + 100°C			
Reflow Temperature	260°C Max. for 10 Seconds			

1. Storage and operating:

- (1). Storage requirements before vacuum bag opened: Temperature<30°C, Humidity<65%RH;
- (2). Check air leakage and vacuum bag damage before opened. If there is any issue found, check the humidity indicator card immediately after bag opened:
 - a. If color changes on “10% circle” of the humidity indicator card only and not the circles of 20% and above, components can be used without additional handling;
 - b. If color changes on both 10% and 20% circles but not the circles of 30% and above, components must be dehumidified according to the conditions of bullet (5);
 - c. If color changes on 10%, 20%, and 30% circle or above, the product should be returned to the supplier for high temperature dehumidification;
- (3). After bag opened, manual soldering or reflow process must follow the following requirements:
 - a. Complete soldering / reflow within 72 hours;
 - b. Requirements of working environment: Temperature<30°C, Humidity<60%RH;
- (4). If the working condition is outside (3)a requirement, the components must be dehumidified according to the conditions of bullet (5);
- (5). Low temperature dehumidification: temperature 60±5°C, at least 24 hours;
- (6). Shelf life: 180 days. If it's over 180 days from the production date on the package label, the components must be dehumidified according to the condition of bullet (5). If customer is unable to dehumidify, return components to LIGHT for dehumidification.

2. Peak Forward Current:

Condition for is IFP pulse: Pulse Width≤0.1ms and duty≤1/10.

3. Caution in ESD:

Static Electricity and surge damages the LED. It is recommend to use a wrist band or anti-electrostatic glove when handling the LED. All devices, equipment and machinery must be properly grounded.

Electrical Optical Characteristics at Ta=25°C

Parameter	Symbol	Color	Min.	Typ.	Max.	Unit	Test Condition
Radiant Intensity	I _e	Infrared	1.5	2.5	---	mW/sr	I _F =20mA
Luminous Intensity	I _v	Green	880	1200	---	mcd	I _F =20mA
		Red	300	450	---	mcd	I _F =20mA
Viewing Angle	2θ _{1/2}	---	---	120	---	Deg.	(Note 2)
Peak Emission Wavelength	λ _p	Infrared	---	940	---	nm	I _F =20mA
		Green	---	515	---	nm	I _F =20mA
		Red	---	635	---	nm	I _F =20mA
Dominant Wavelength	λ _d	Green	520	---	530	nm	I _F =20mA
		Red	617	---	627	nm	I _F =20mA
Spectral Line Half-Width	Δλ	Infrared	---	35	---	nm	I _F =20mA
		Green	---	25	---	nm	I _F =20mA
		Red	---	15	---	nm	I _F =20mA
Forward Voltage	V _F	Infrared	1.2	---	1.8	V	I _F =20mA
		Green	2.6	---	3.4	V	I _F =20mA
		Red	1.8	---	2.4	V	I _F =20mA
Reverse Current	I _R	---	---	---	10	μA	V _R =5V

Note:

1. Luminous intensity is measured with a light sensor and filter combination that approximates the CIE eye-response curve. Tolerance of Luminous Intensity: ±15%.
2. θ_{1/2} is the off-axis angle at which the luminous intensity is half the axial luminous intensity.
3. The dominant wavelength, λ_d is derived from the CIE chromaticity diagram and represents the single wavelength which defines the color of the device. Tolerance of Dominant Wavelength: ±1.0nm.
4. Tolerance of Forward Voltage: ±0.1V.

Typical Electrical / Optical Characteristics Curves for Infrared (25°C Ambient Temperature Unless Otherwise Noted)

Fig.1 Spectral Distribution

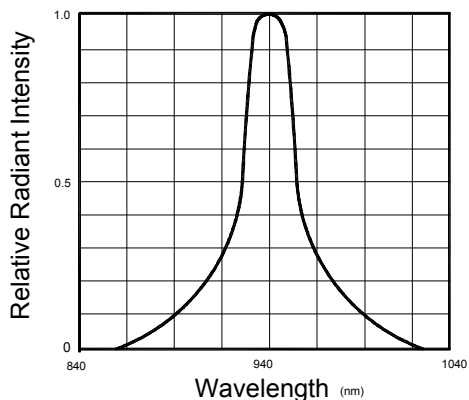

Fig.2 Forward Current Vs Ambient Temperature

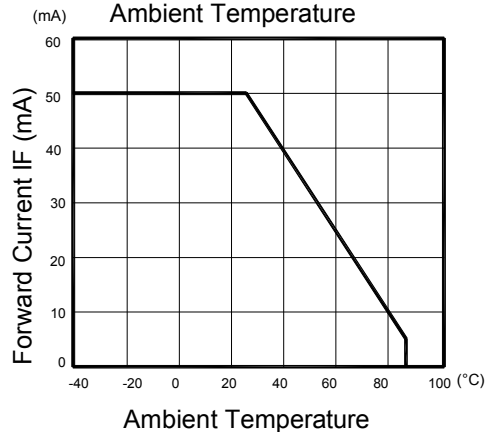

Fig.3 Forward Current Vs Forward Voltage

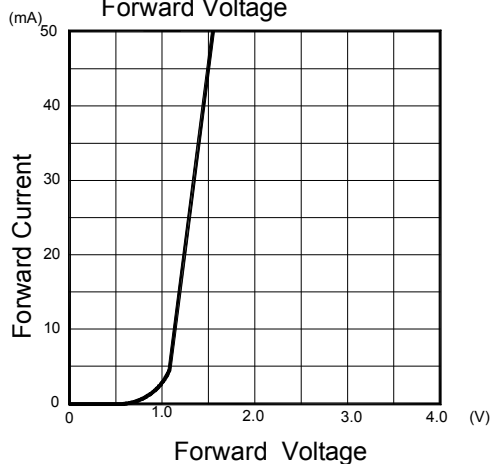

Fig.4 Relative Radiant Intensity Vs Ambient Temperature

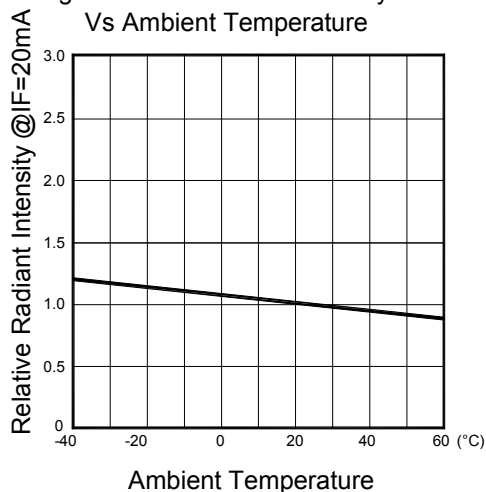

Fig.5 Relative Radiant Intensity Vs Forward Current

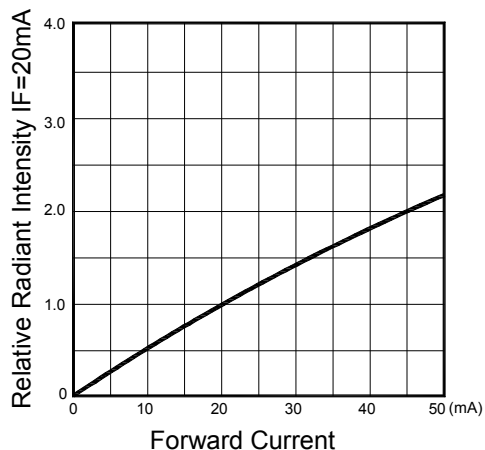
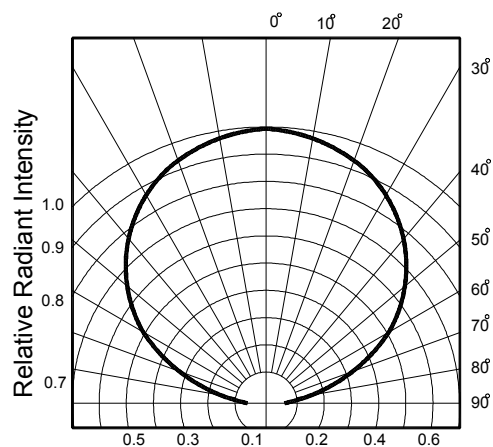

Fig.6 Radiation Diagram



Typical Electrical / Optical Characteristics Curves for Green (25°C Ambient Temperature Unless Otherwise Noted)

Fig.1 Spectral Distribution

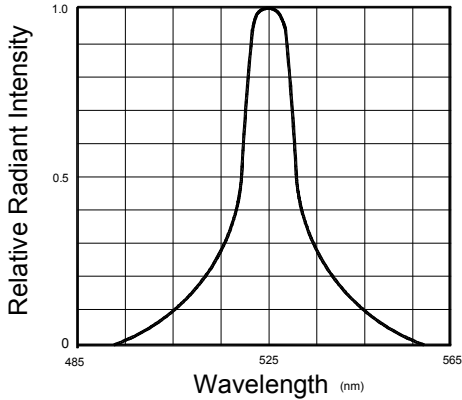

Fig.2 Forward Current Vs Ambient Temperature

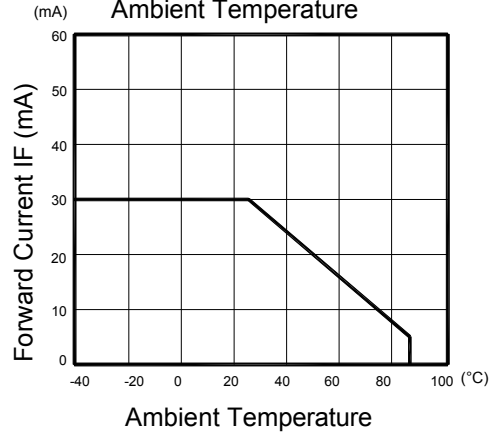

Fig.3 Forward Current Vs Forward Voltage

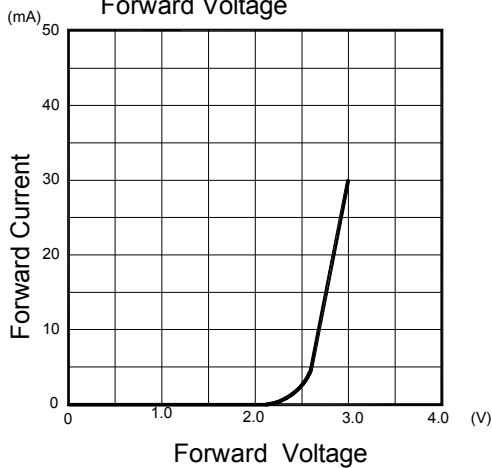

Fig.4 Relative Radiant Intensity Vs Ambient Temperature

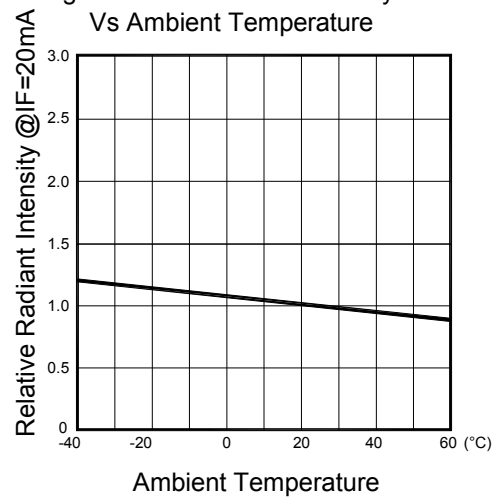

Fig.5 Relative Radiant Intensity Vs Forward Current

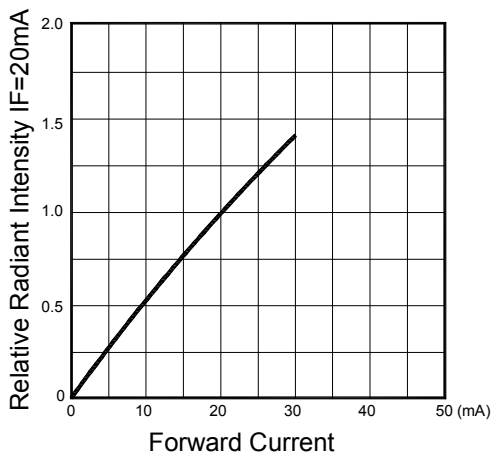
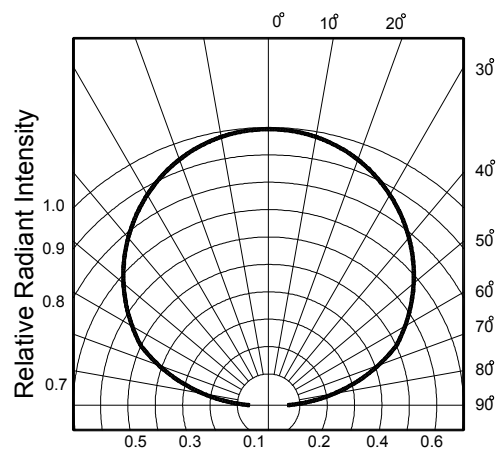

Fig.6 Radiation Diagram



Typical Electrical / Optical Characteristics Curves for Red (25°C Ambient Temperature Unless Otherwise Noted)

Fig.1 Spectral Distribution

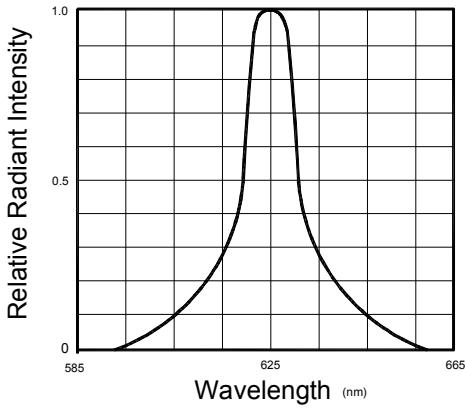

Fig.2 Forward Current Vs Ambient Temperature

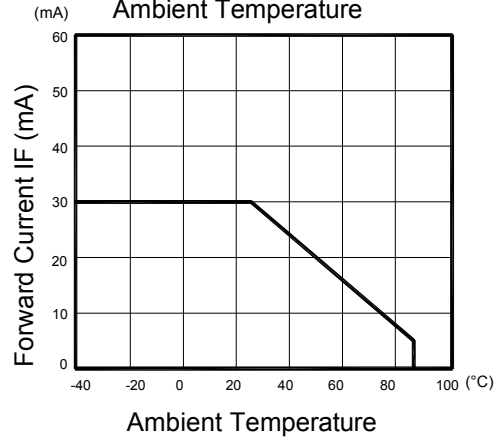

Fig.3 Forward Current Vs Forward Voltage

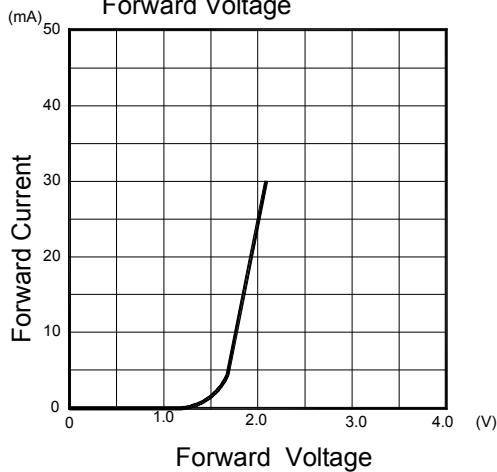

Fig.4 Relative Radiant Intensity Vs Ambient Temperature

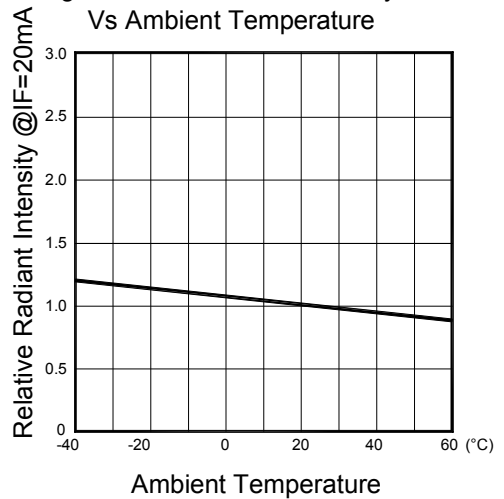

Fig.5 Relative Radiant Intensity Vs Forward Current

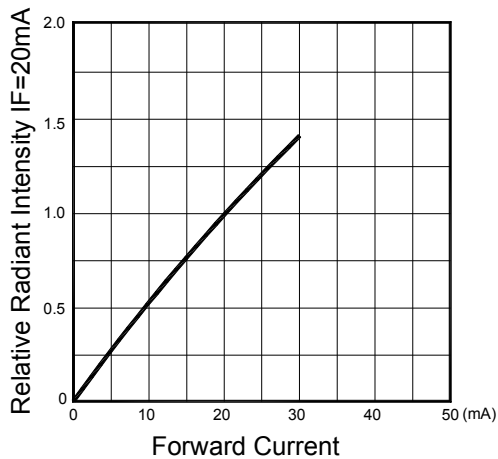
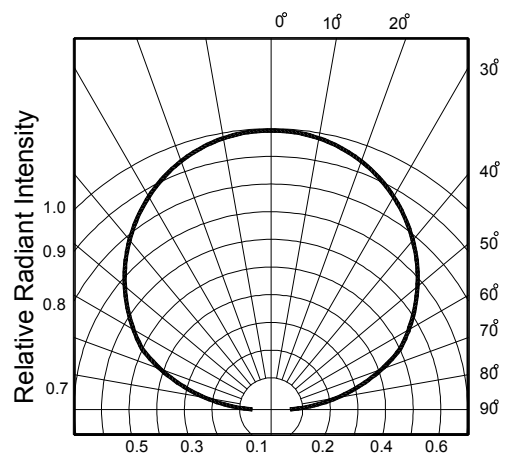

Fig.6 Radiation Diagram



Label Explanation

LIGHT Universal Label

LIGHT 深圳莱特光电股份有限公司  Light Electronics CO., LTD.	
产品型号 MODEL NAME:	 LOT NO. :
数量 QUANTITY:	
等级 BIN:	
包装日期 PACKING DATE:	
备注 REMARKS:	

Customer Defined Label

LIGHT 深圳莱特光电股份有限公司  Light Electronics CO., LTD.	
产品型号 MODEL NAME:	 LOT NO. :
数量 QUANTITY:	
等级 BIN:	
包装日期 PACKING DATE:	
客户料号 CUSTOMER P/N:	

Reel Dimensions

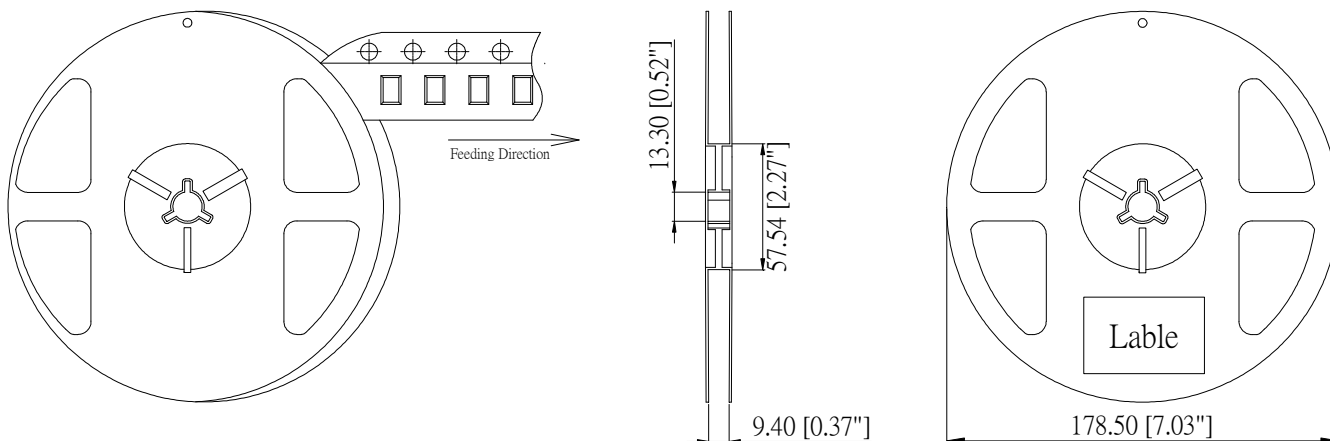

Note: Tolerance unless mentioned is $\pm 0.2\text{mm}$; Unit = mm

Carrier Tape Specifications (Loaded Quantity: 5000pcs/reel)

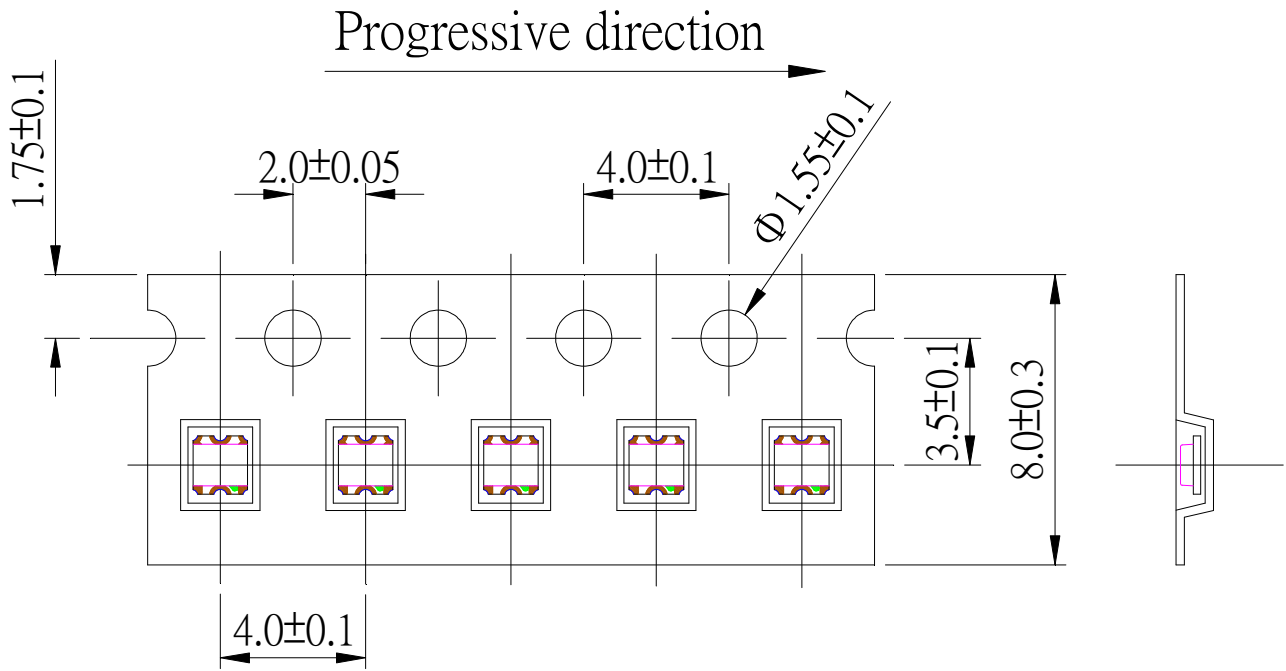

Moisture Resistant Packaging

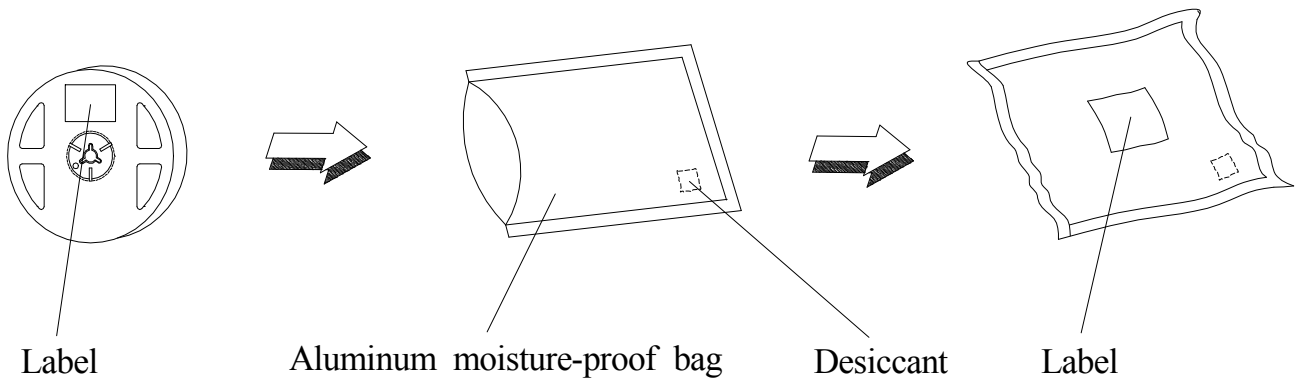

Suggest IR Reflow Condition For Lead Free

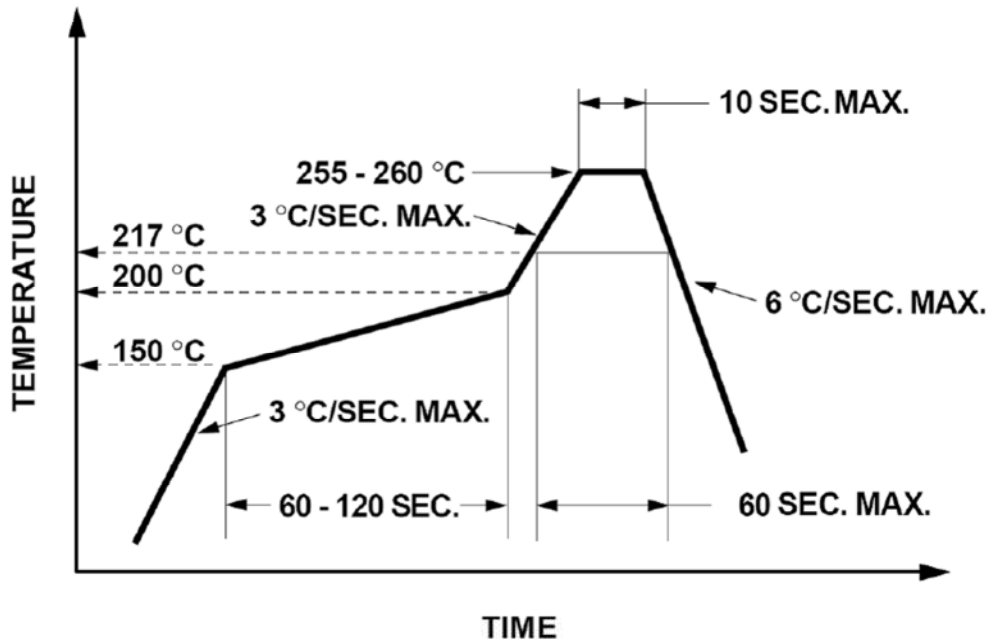

1. Reflow soldering should not be done more than two times.
2. When soldering, do not put stress on the LEDs during heating.

Soldering iron

1. When hand soldering, the temperature of the iron must less than 300 °C for 3 seconds.
2. The hand solder should be done only once.

Repairing

Repair should not be done after the LEDs have been soldered. When repairing is unavoidable, a double-head soldering iron should be used (as below figure). It should be confirmed beforehand whether the characteristics of LEDs will or will not be damaged by repairing.

