

# **SL-T3020IRC050-L268-A**

## **DATA SHEET**

SPEC. NO. : SZ19120501  
DATE : 2022/09/26  
REV. : B/0

Approved By:

Checked By:

Prepared By:

## Features

- ◆ Pb free product—RoHS compliant
- ◆ Low power consumption, High efficiency
- ◆ Reliable and rugged
- ◆ Long life – solid state reliability
- ◆ Radiant angle: 68°

## Package Dimension

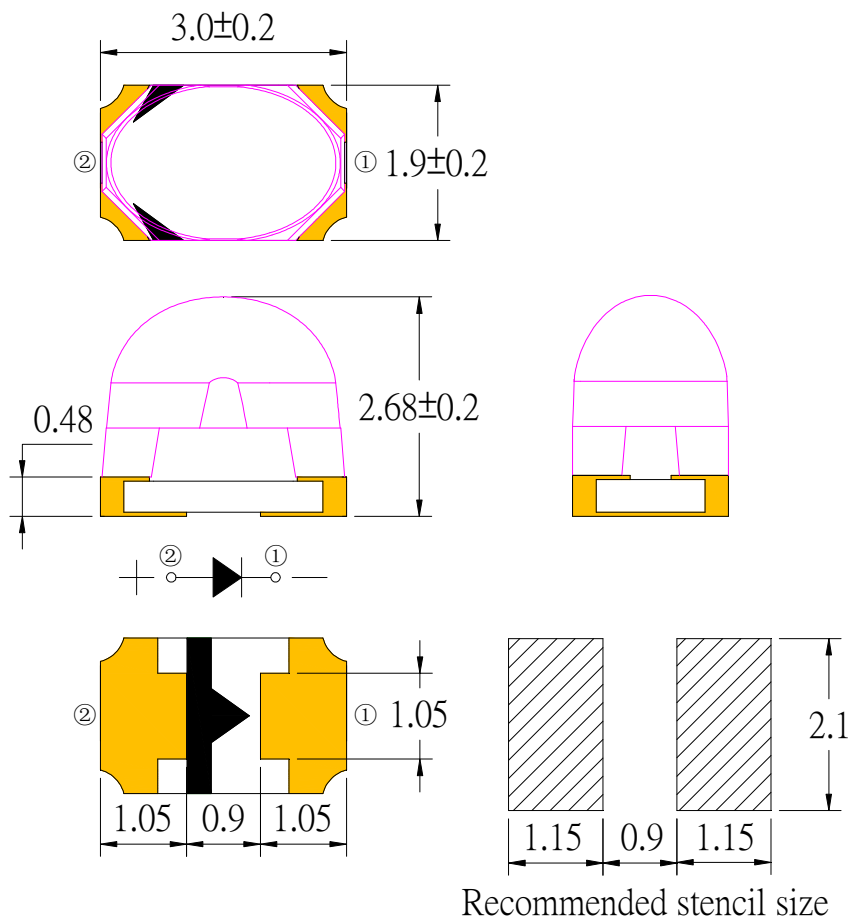

Part NO.	Chip Material	Lens Color
SL-T3020IRC050-L268-A	AlGaAs/Si	Water Clear

### Notes:

1. All dimensions are in millimeters.
2. Tolerance is  $\pm 0.10$  mm unless otherwise noted.
3. Specifications are subject to change without notice.

## Absolute Maximum Ratings at Ta=25°C

Parameter	MAX.	Unit
Power Dissipation	180	mW
Continuous Forward Current	100	mA
Peak Forward Current* <sup>2</sup>	1000	mA
Reverse Voltage	5	V
Electrostatic Discharge (HBM)* <sup>3</sup>	4000	V
Moisture Sensitivity Level* <sup>1</sup>	4	
Operating Temperature	-40°C to + 85°C	
Storage Temperature	-40°C to + 100°C	
IR Reflow Temperature	260°C for 10 Seconds MAX.	
Hand Soldering Condition	300°C for 3 Seconds MAX.	

### 1. Storage and operating:

- (1). Storage requirements before vacuum bag opened: Temperature<30°C, Humidity<65%RH;
- (2). Check air leakage and vacuum bag damage before opened. If there is any issue found, check the humidity indicator card immediately after bag opened:
  - a. If color changes on “10% circle” of the humidity indicator card only and not the circles of 20% and above, components can be used without additional handling;
  - b. If color changes on both 10% and 20% circles but not the circles of 30% and above, components must be dehumidified according to the conditions of bullet (5);
  - c. If color changes on 10%, 20%, and 30% circle or above, the product should be returned to the supplier for high temperature dehumidification;
- (3). After bag opened, manual soldering or reflow process must follow the following requirements:
  - a. Complete soldering / reflow within 72 hours;
  - b. Requirements of working environment: Temperature<30°C, Humidity<60%RH;
- (4). If the working condition is outside (3)a requirement, the components must be dehumidified according to the conditions of bullet (5);
- (5). Low temperature dehumidification: temperature 60±5°C, at least 24 hours;
- (6). Shelf life: 180 days. If it's over 180 days from the production date on the package label, the components must be dehumidified according to the condition of bullet (5). If customer is unable to dehumidify, return components to LIGHT for dehumidification.

### 2. Peak Forward Current:

Condition for is IFP pulse: Pulse Width≤100μs and duty≤1%.

### 3. Caution in ESD:

Static Electricity and surge damages the LED. It is recommend to use a wrist band or anti-electrostatic glove when handling the LED. All devices, equipment and machinery must be properly grounded.

### Electrical Optical Characteristics at Ta=25°C

Parameter	Symbol	Min.	Typ.	Max.	Unit	Test Condition
Radiant Intensity(0°)	I <sub>e</sub>	8.8	12.5	---	mW/sr	I <sub>F</sub> =20mA (Note 1,3)
		22	35	---	mW/sr	I <sub>F</sub> =50mA (Note 1,3)
Viewing Angle(X)	2θ <sub>1/2</sub>	62	68	75	Deg.	(Note 2)
Viewing Angle(Y)		13	18	25		
Peak Wavelength	λ <sub>p</sub>	---	940	---	nm	I <sub>F</sub> =50mA
Spectral Line Half- Width	Δλ	---	50	---	nm	I <sub>F</sub> =50mA
Forward Voltage	V <sub>F</sub>	1.25	1.35	1.60	V	I <sub>F</sub> =50mA
Rise Time/Fall Time	tr/tf	---	15	---	ns	I <sub>F</sub> =50mA
Reverse Current	I <sub>R</sub>	---	---	10	μA	V <sub>R</sub> =5V

**Note:**

- Point sources of the amount of radiation per unit time in a given direction within the unit solid Angle radiated energy.
- θ<sub>1/2</sub> is the off-axis angle at which the Radiant Intensity is half the axial Radiant Intensity.
- The I<sub>e</sub> guarantee should be added ±15% tolerance.

## Typical Electrical / Optical Characteristics Curves (25°C Ambient Temperature Unless Otherwise Noted)

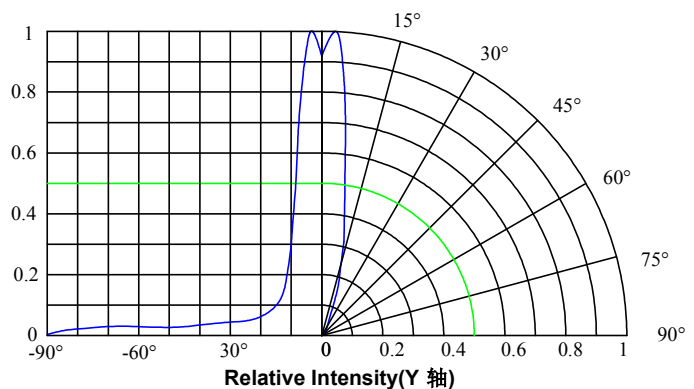
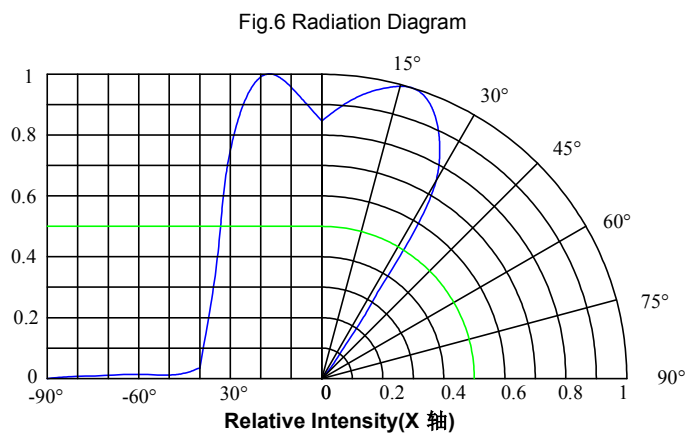
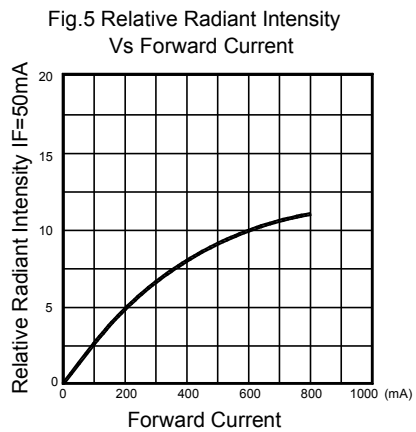
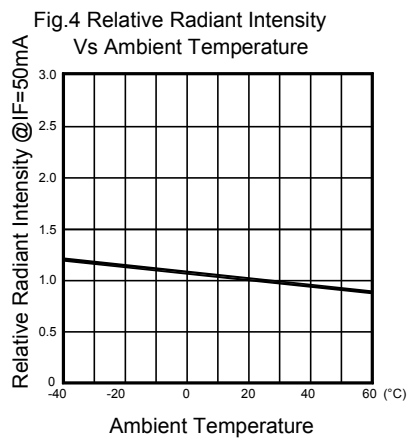
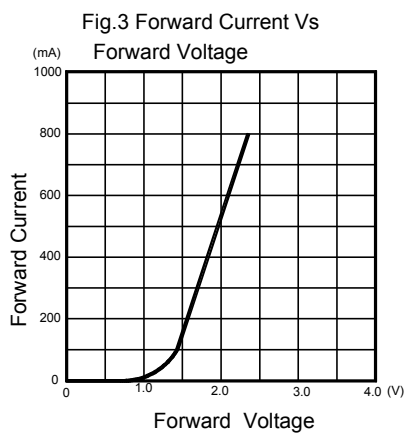
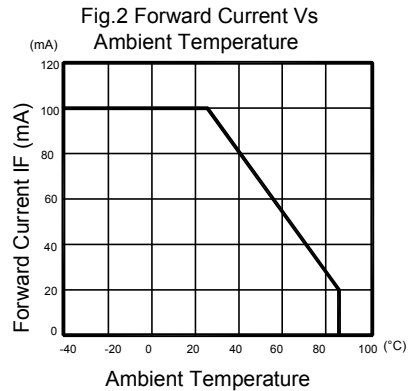
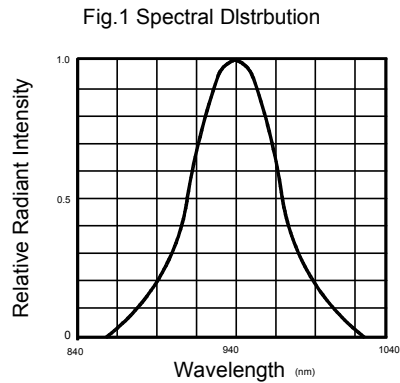

### Radiant Intensity Bin Code (IF=50mA)

BIN CODE	Min.(mW/sr)	Max. (mW/sr)
31	22	26
32	26	31.9
33	31.9	37
34	37	44
35	44	53

**NOTE:** The I<sub>e</sub> guarantee should be added ±15% tolerance.

## Label Explanation

LIGHT Universal Label

<b>LIGHT</b> 深圳莱特光电股份有限公司  Light Electronics CO., LTD.	
产品型号 MODEL NAME: _____ 数量 QUANTITY: _____ 等级 BIN: _____ 包装日期 PACKING DATE: _____ 备注 REMARKS: _____	LOT NO. : 

Customer Defined Label

<b>LIGHT</b> 深圳莱特光电股份有限公司  Light Electronics CO., LTD.	
产品型号 MODEL NAME: _____ 数量 QUANTITY: _____ 等级 BIN: _____ 包装日期 PACKING DATE: _____ 客户料号 CUSTOMER P/N: _____	LOT NO. : 

## Reel Dimensions

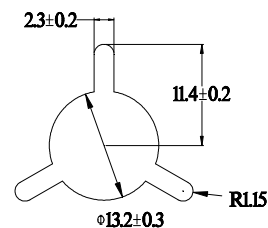
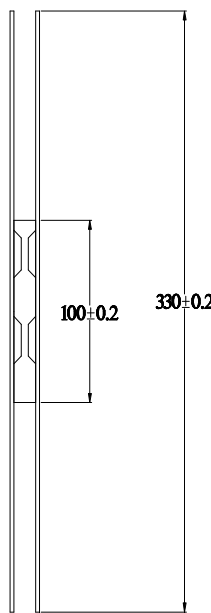
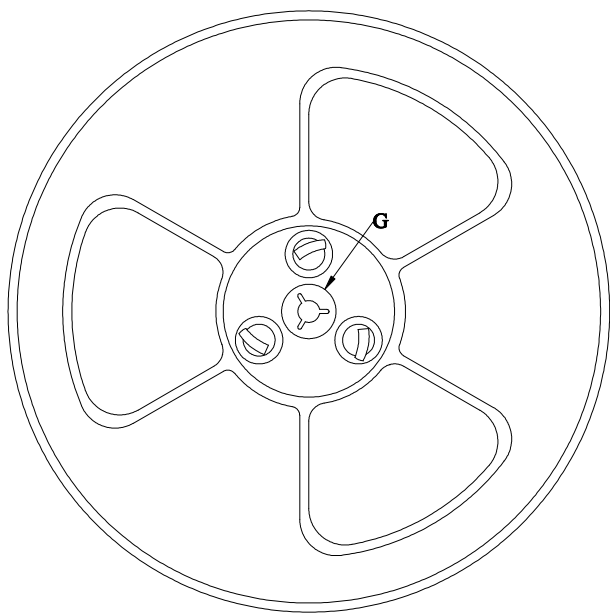

G区放大图

**Note:** Tolerance unless mentioned is  $\pm 0.2\text{mm}$ ; Unit = mm

## Carrier Tape Specifications (Loaded Quantity: 5000pcs/reel)

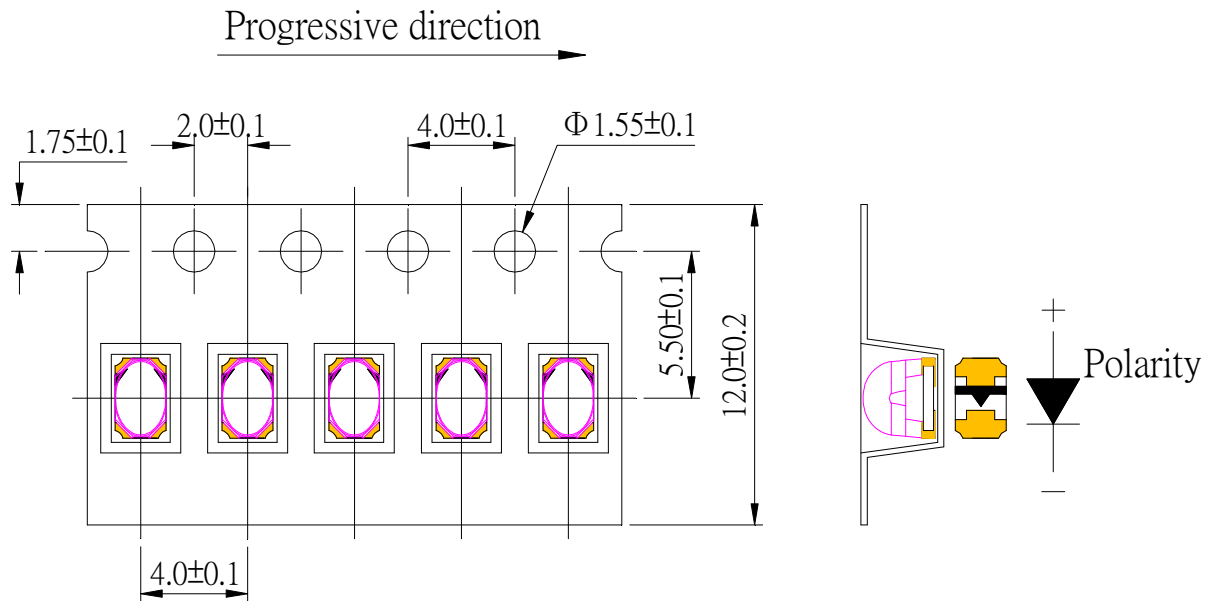

**Note:** Tolerance unless mentioned is  $\pm 0.1$  mm; Unit = mm

## Moisture Resistant Packaging

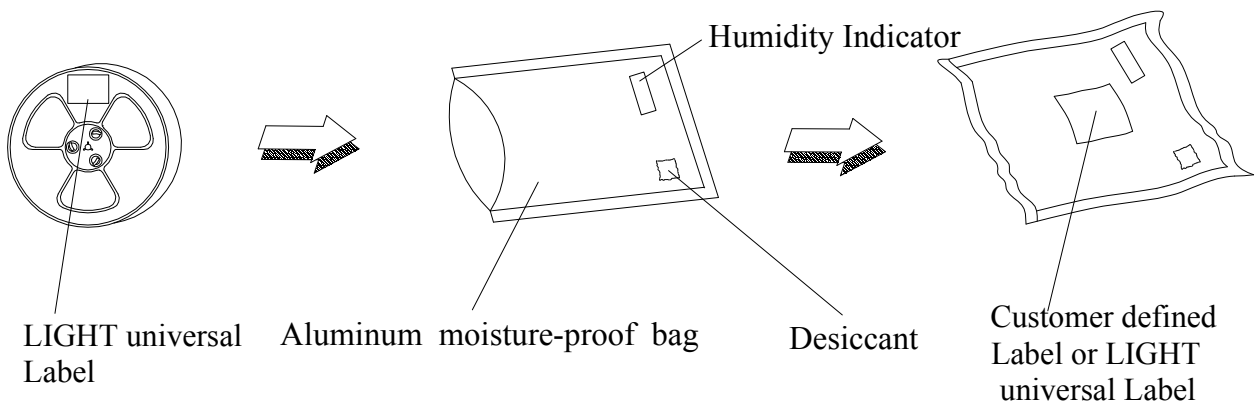



## Suggest IR Reflow Condition For Lead Free

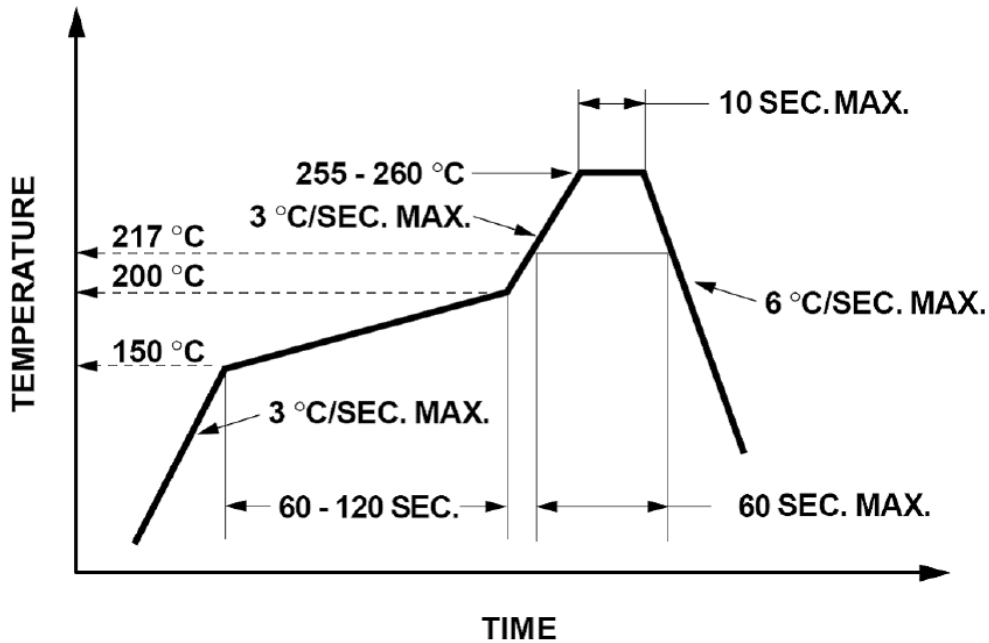

1. Reflow soldering should not be done more than two times.
2. When soldering, do not put stress on the LEDs during heating.

## Soldering iron

1. When hand soldering, the temperature of the iron must less than 300 °C for 3 seconds.
2. The hand solder should be done only once.

## Repairing

Repair should not be done after the LEDs have been soldered. When repairing is unavoidable, a double-head soldering iron should be used (as below figure). It should be confirmed beforehand whether the characteristics of LEDs will or will not be damaged by repairing.

